

# 1 **BRAVILOR BONAMAT**

## *Thermal Brewer Aurora*

FI Käyttöopas



digital 758F (FI)

GTBSH-001	GTBSH-002	GTBSH-003	GTBSH-004	
GTBTH-001	GTBTH-002	GTBTH-003	GTBTH-004	
GTBSL-001	GTBSL-002	GTBSL-003	GTBSL-004	GTBSH-005
GTBTL-001	GTBTL-002	GTBTL-003	GTBTL-004	

[www.bravilor.com](http://www.bravilor.com)



Suomi



Tietoa



Sisällysuuttelo



Turvaohjeet



Käsittely



Valinta



Virtakytkin



Puhdistaminen



Säiliö



Säiliö ilman alustaa



Kannu



Pumpputermoskannu



Vesi



Valitse säiliö



Valitse resepti



Valitse määrä



Valmistus



Signaali



Odota



Lopeta valmistus



Kuuma neste



Suodatinnallas



Suutin



Harja



Suomi



Kolikko



Kostea liina



Huuhtelu



Pesuaine



Kestää konepesun



Ohjelmointi



Viestit



Soita tavarantoimittajalle



FCC- ja IC-vakuutukset



Paina VALIKKO



Pidä VALIKKO painettuna



Paina MÄÄRÄ



Paina VASEN/OIKEA

Pidä VASEN/OIKEA  
painettunaPaina KÄYNNISTYS/  
PYSÄYTYS

Automaattinen toiminta

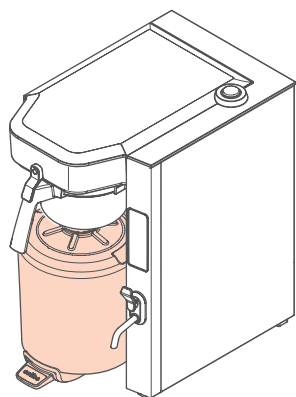

***Aurora Single Low***

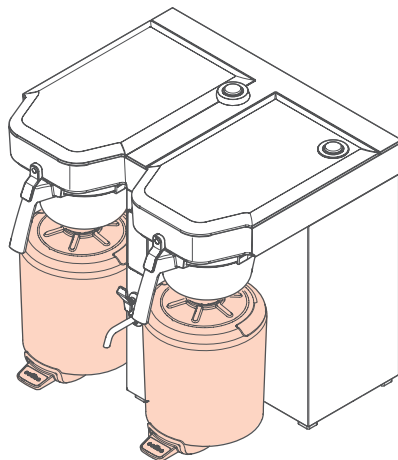

***Aurora Twin Low***

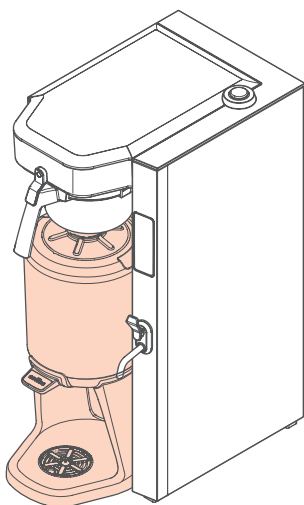

***Aurora Single High***

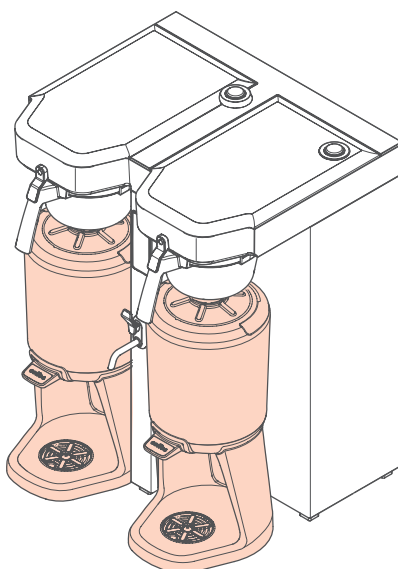















***Aurora Twin High***



FI

Lue oheinen turvaohje huolellisesti. Jos turvaohje puuttuu, käy osoitteessa [www.bravilor.com](http://www.bravilor.com). Käyttöopas (osa 2) - joka on myös liitteenä - sisältää luvut Asennus, Kalkinpoisto ja Ohjelmointi.



	_____	<b>9</b>
  	_____	<b>10</b>
 	_____	<b>13</b>
  	_____	<b>14</b>
	_____	<b>15</b>
 	_____	<b>16</b>
 	_____	<b>17</b>
<b>P</b>	_____	<b>19</b>
<b>E</b>	_____	<b>33</b>
<b>E</b> 	_____	<b>34</b>
<b>FC</b>	_____	<b>35</b>





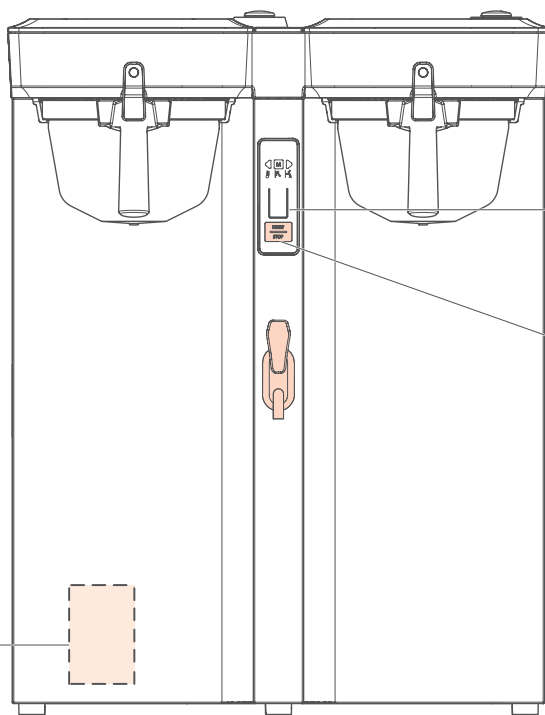
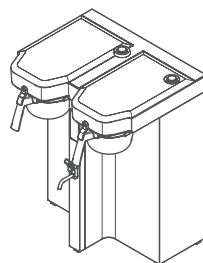
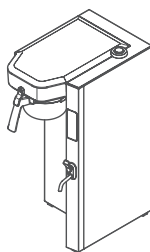
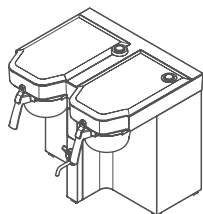
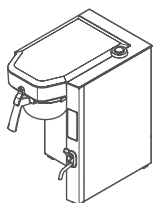

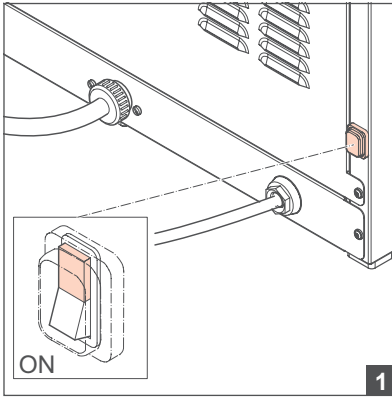

FI lämmitys

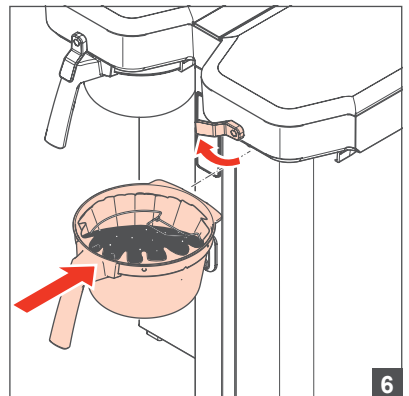
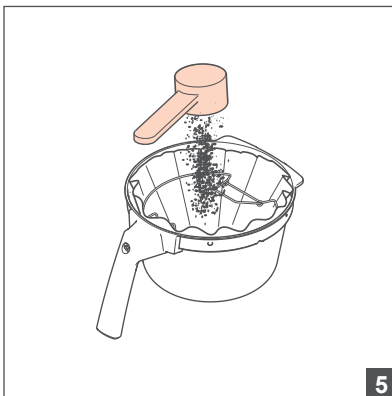
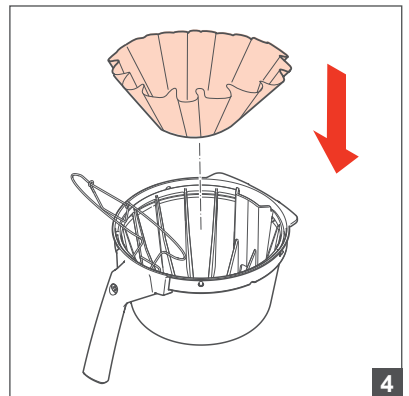
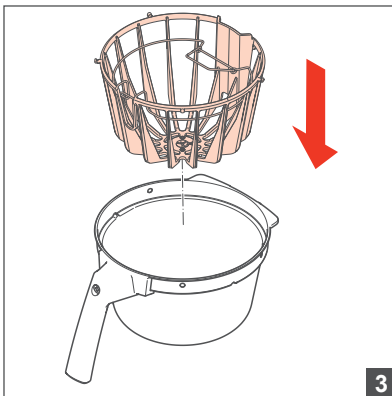
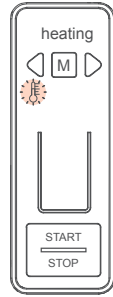

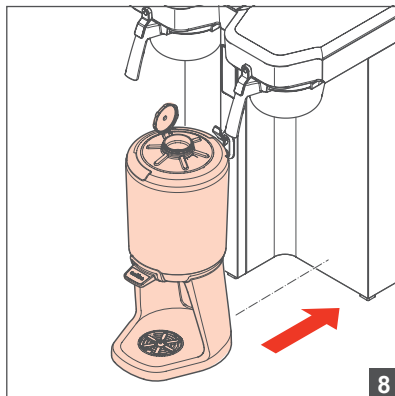
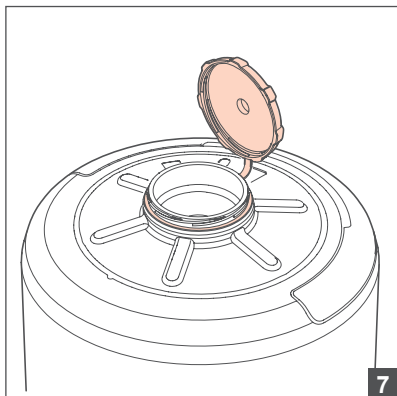

**FI** ## litraa  
"resepti x"

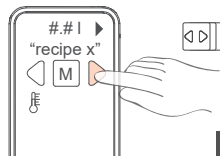
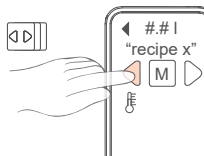
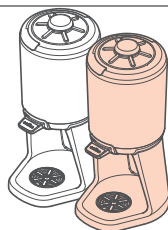
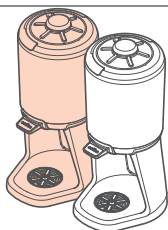

**9**



**FI** ## litraa  
"resepti x/y/z"

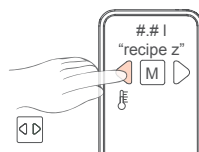
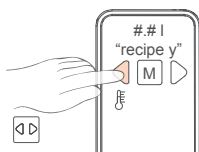
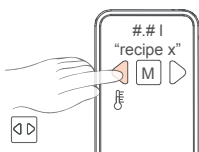
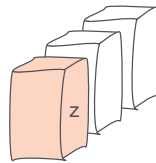
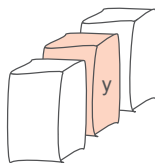
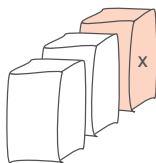

**10**



FI #.# litraa  
"resepti x"

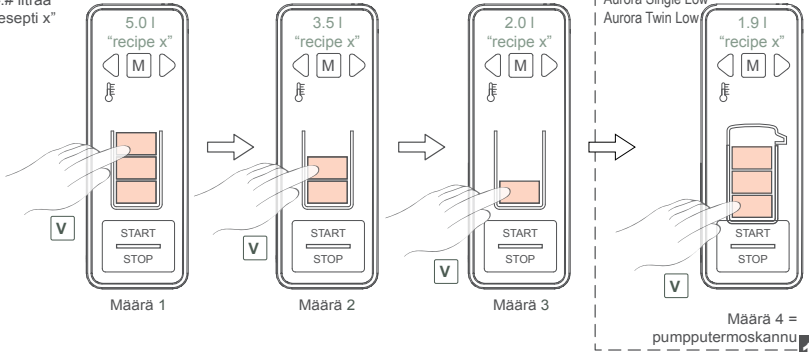

FI #.# litraa/valmistelu  
"resepti x"

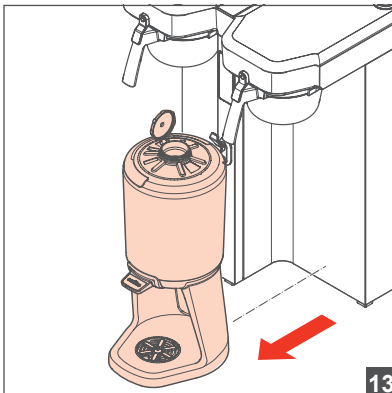
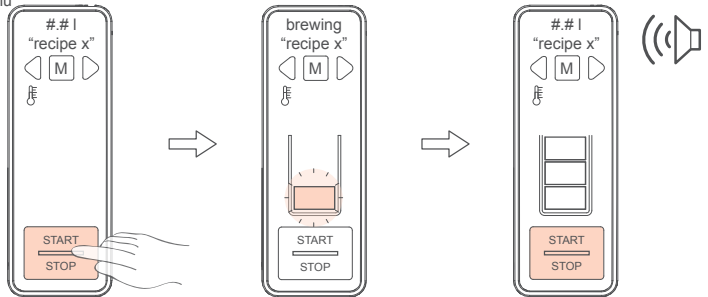



FI valmistus  
käynnissä  
keskeytetty

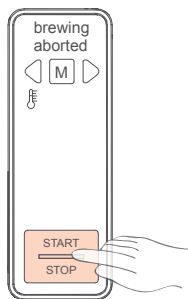

1

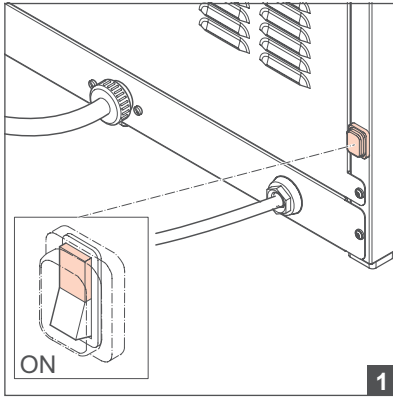

Fi lämmitys

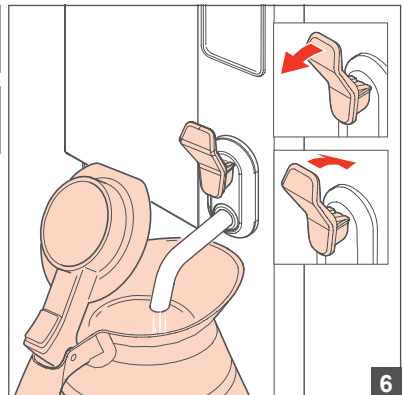
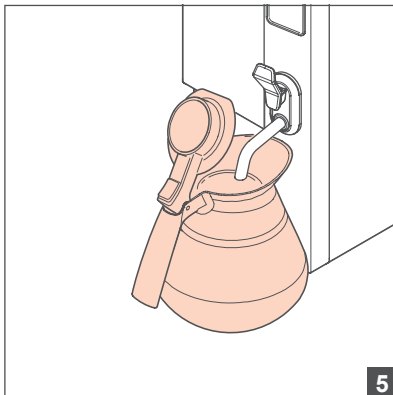
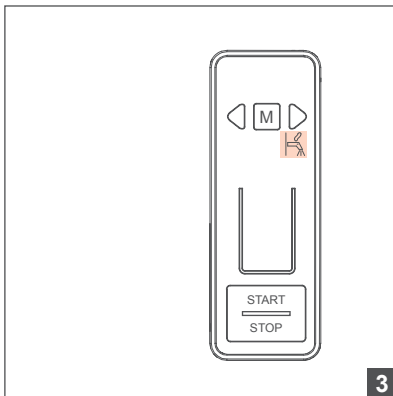
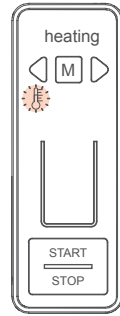

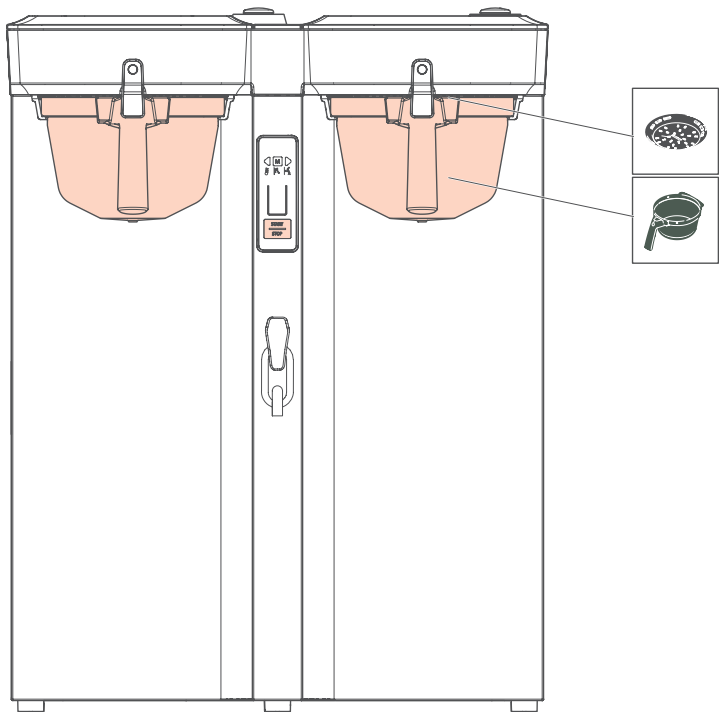
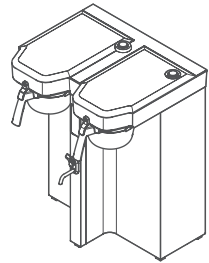
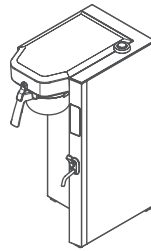
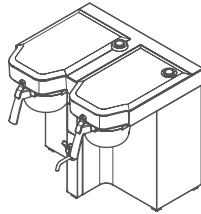
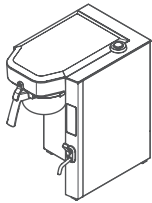

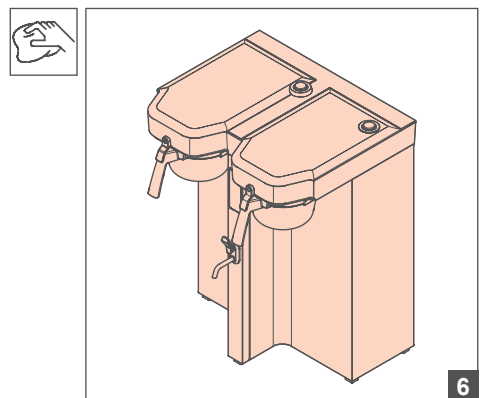
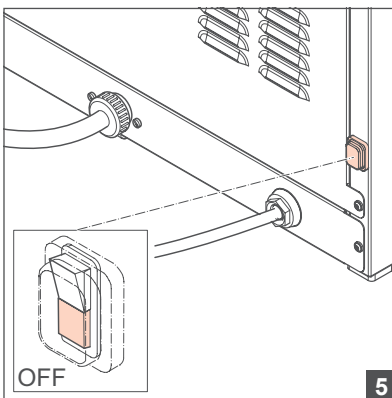
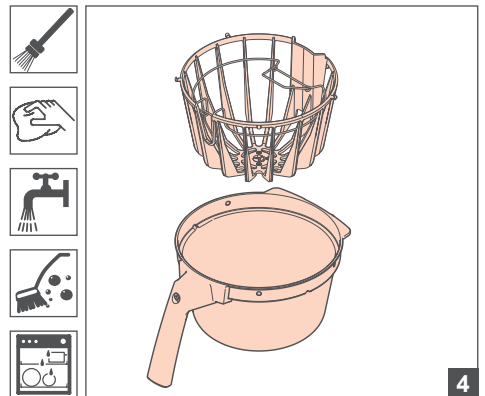
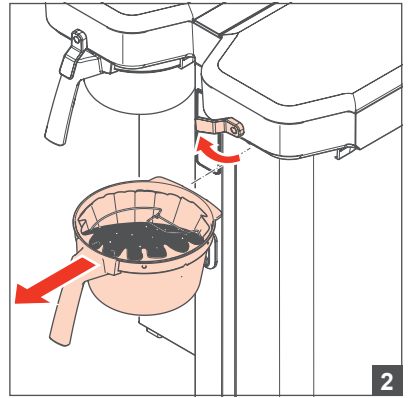
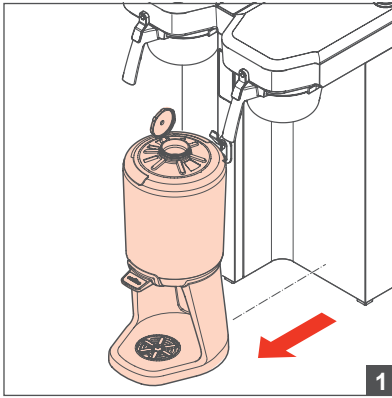



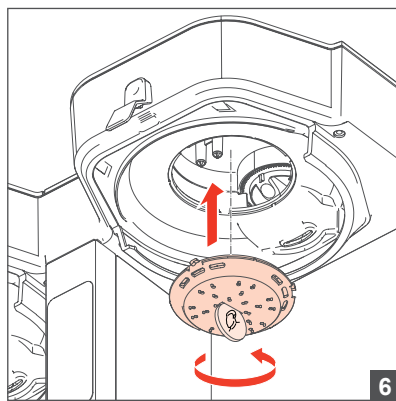
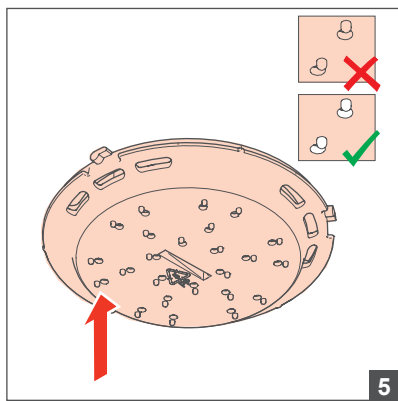
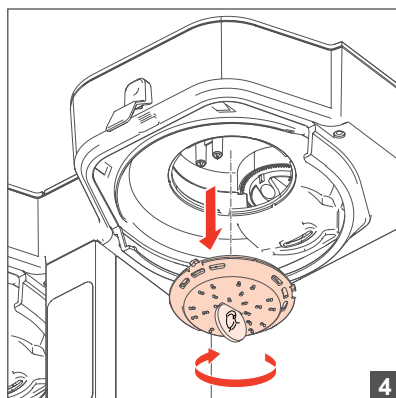
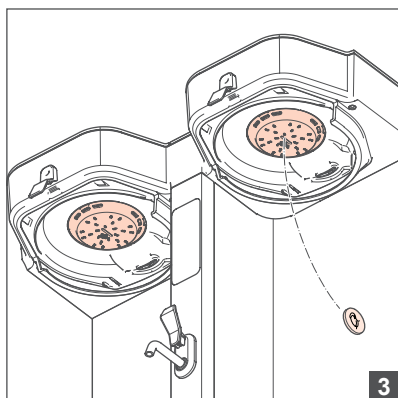
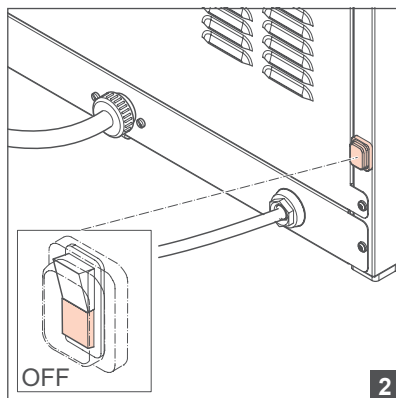
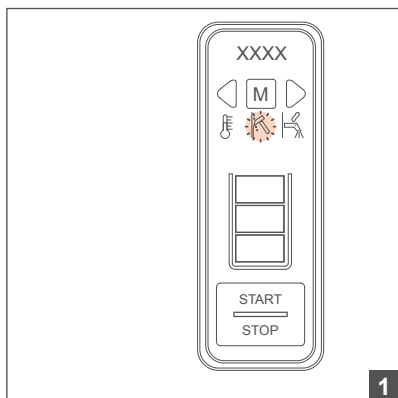



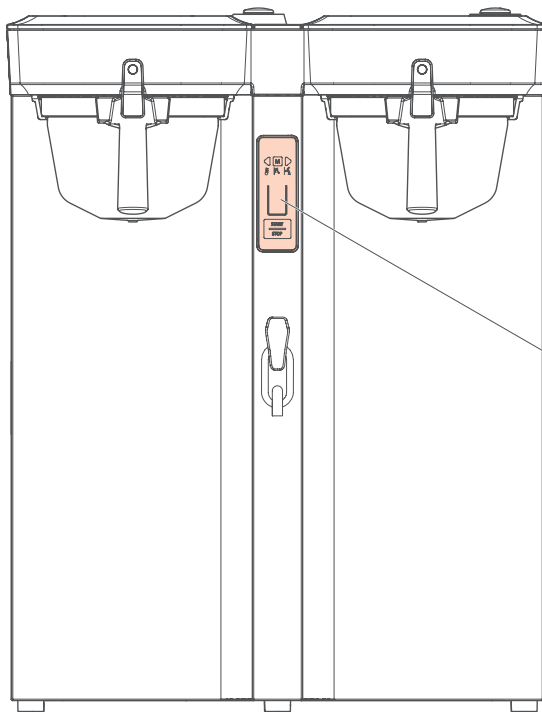
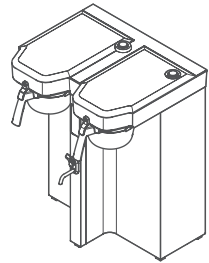
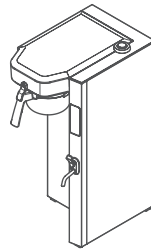
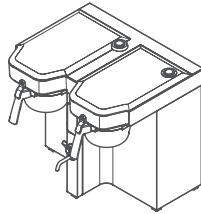
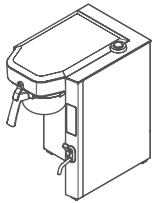

## NÄYTTÖ

Näytön kautta ollaan yhteydessä koneeseen, painikkeisiin ja teksti-ikkunaan.

### Teksti-ikkuna

Teksti-ikkunassa (1) voi näkyä:

- valikot
- valikon kohdat
- asetukset
- komennot
- automaattiset prosessit

Jos sinulla on kaksoiskone, musta nuoli (2) osoittaa, onko käytössä vasen vai oikea keitin.

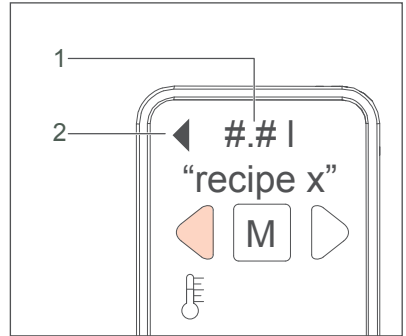

### Painikkeet

Painikkeilla voi navigoida koneen valikoissa.

1. VALIKKO-painike
2. VASEN/OIKEA-painike
3. MÄÄRÄ-painike
4. KÄYNNISTYS/PYSÄYTYS

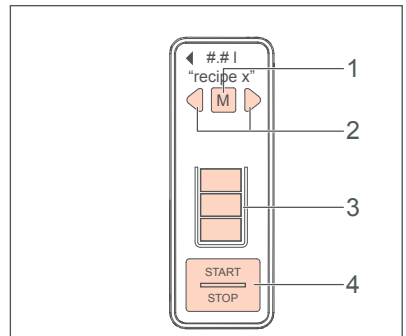

### Valikot

Perustoiminto sisältää valikot seuraavia varten:

- reseptin valinta
- kuinka voit muuttaa valmistamasi kahvin määrän
- käynnistä tai pysäytä kone

Käyttäjän valikoissa voit tehdä haluamasi valinnat. Valikoissa voit:

- laatia, muuttaa ja ladata reseptejä koneelle tai koneelta
- muuttaa lämpötilan, kalenterin, ajan ja koneen asetuksia
- muuttaa koneen ohjelmien asetuksia, kuten:
  - Eco
  - Vedensuodatin
  - Kalkinpoisto
  - Puhdistaminen

## Navigointi

Paina navigointipainikkeita.

Tässä käyttöoppaassa määritellään kaksi erilaista tapaa painikkeiden painamiseen:

- Paina painiketta: kosketa painiketta lyhyesti.
- Pidä painike painettuna: kosketa painiketta vähintään 1 sekunti.

Tapa jolla painiketta painetaan vaikuttaa toimintoon näytössä.

## Painikkeiden komennot

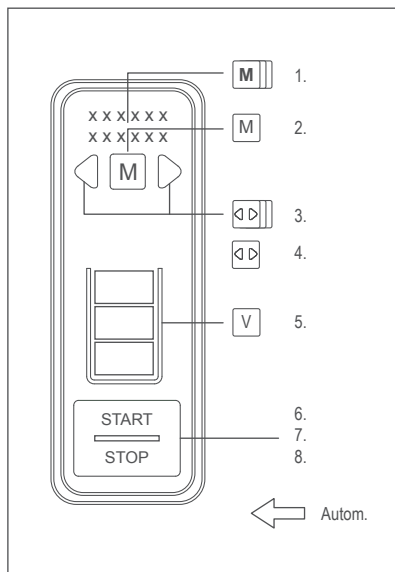

1. Pidä VALIKKO-painike painettuna 1 sekunnin ajan, jotta vahvistat valinnan valikon tasolla.
2. Paina VALIKKO-painiketta lyhyesti siirtyäksesi valikon seuraavalle tasolle.
3. Pidä VASEN/OIKEA-painike painettuna vaihtaaksesi keitintä (vain kaksoismallissa).
4. Paina VASEN/OIKEA-painiketta lyhyesti voidaksesi selata valikon eri vaihtoehtoja.
5. Paina MÄÄRÄ-painiketta lyhyesti vaihtaaksesi valmistamaasi määrää.
6. Pidä KÄYNNISTYS/PYSÄYTYS-painike painettuna valmistuksen aloittamiseksi.
7. Kun pidät KÄYNNISTYS/PYSÄYTYS-painikkeen painettuna tai painat sitä, valmistus keskeytyy.
8. Paina KÄYNNISTYS/PYSÄYTYS-painiketta lyhyesti palataksesi valikon edelliselle tasolle.

## Automaattiset prosessit

Automaattiset prosessit

Valkoiset nuolet ilmaisevat koneen suorittamat automaattiset prosessit.

FI

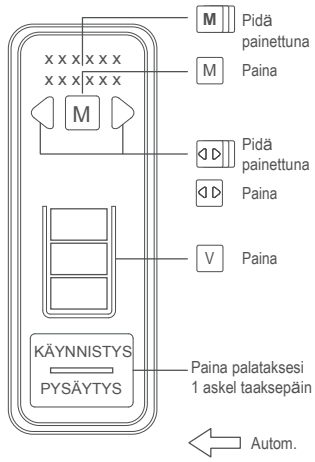

- Kaksoismallit
- Valinnainen tai vain mataliin malleihin
- ” xx ” Kiinteä arvo
- [ xx ] Tätä arvoa voi muuttaa

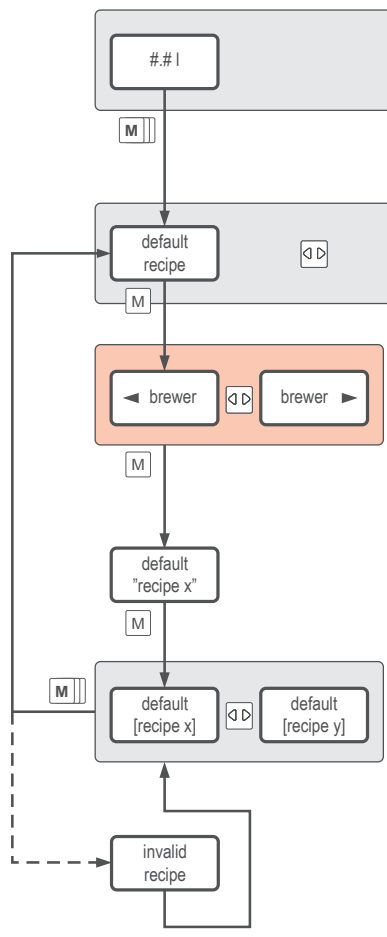

1 Käyttäjän valikko

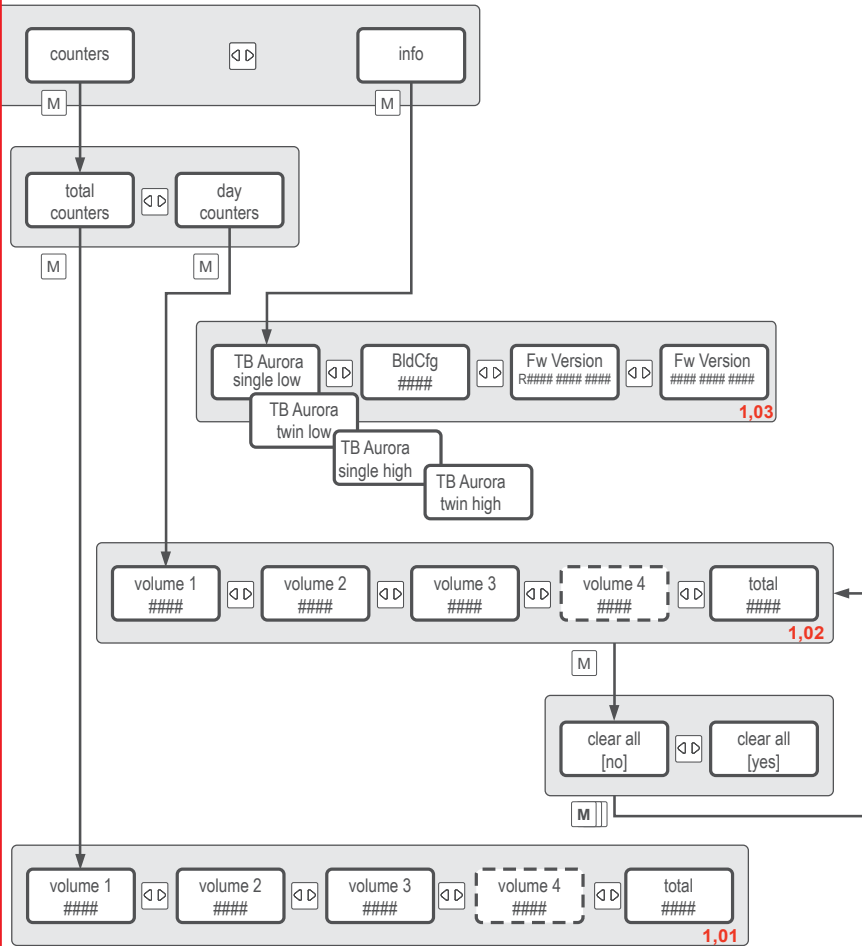





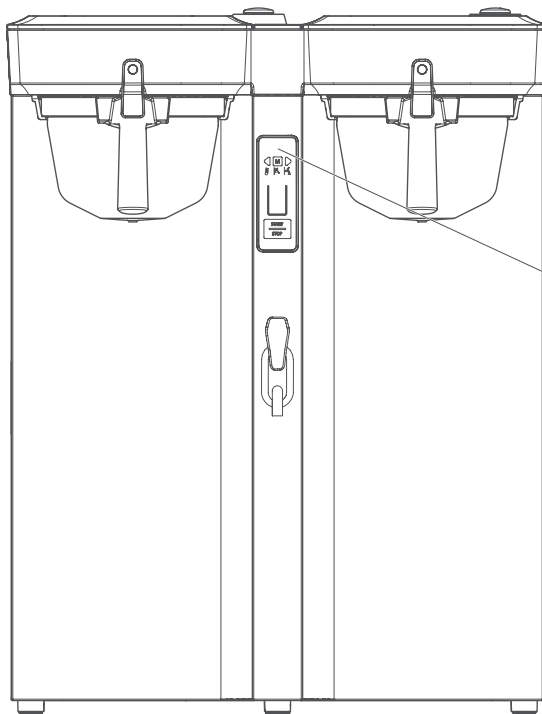
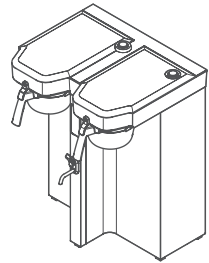
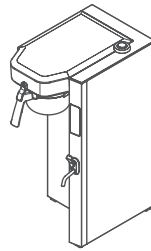
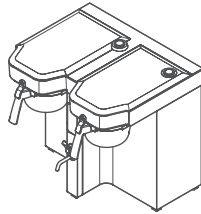
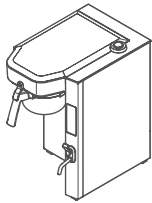

**E**

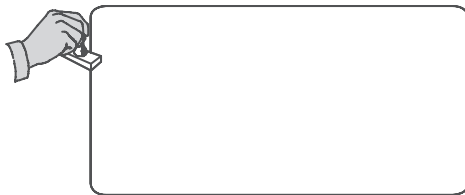
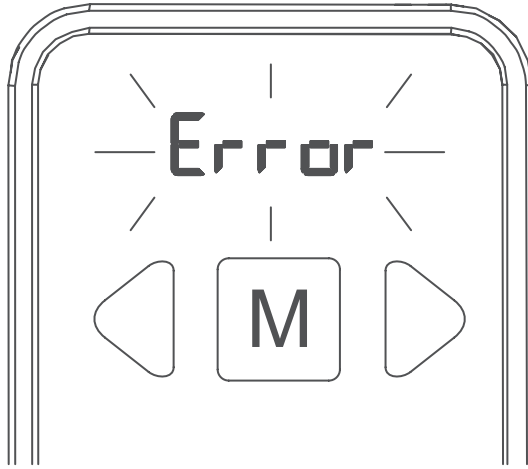

FI

**Vastaavuusvakuutus (osa 15.19)**

Tämä laite on FCC-sääntöjen osan 15 ja Industry Canadian lisenssivapaita laitteita koskevien RSS-standardien mukainen.

Käytön edellytyksenä ovat seuraavat ehdot:

- (1) tämä laite ei saa aiheuttaa haitallista häiriötä, ja
- (2) tämän laitteen on vastaanotettava kaikki häiriöt, mukaan lukien häiriöt, jotka voivat haitata laitteen toimintaa.

**Varoitus (osa 15.21)**

Muutokset, joita vaatimustenmukaisuudesta vastaava osapuoli ei ole nimenomaan hyväksynyt, voivat mitätöidä käyttäjän oikeuden laitteen käyttöön.

Tämä koskee etenkin tuotteen mukana toimitettua antennia.

**Tietoja käyttäjälle (osa 15.105 (b))**

Huomio: Tämä laite on testattu ja sen on todettu täyttävän luokan B digitaalisen laitteen rajoitukset FCC-sääntöjen osan 15 mukaisesti. Nämä rajoitukset on laadittu, jotta varmistettaisiin kotitalouksissa käytettävän laitteen kohtuullinen suoja haitallisia häiriöitä vastaan. Tämä laite synnyttää, käyttää ja voi säteillä radiotaajuusenergiaa ja mikäli sitä ei asenneta ja käytetä näiden ohjeiden mukaisesti, se voi aiheuttaa haitallista häiriötä radioyhteyksille. Ei kuitenkaan anneta takuuta siitä, että häiriötä ei esiinny tietyssä laitteessa. Jos tämä laite aiheuttaa haitallista häiriötä radio- tai televisiolähetyksille, minkä voi todeta kytkemällä laite päälle ja pois päältä, käyttäjän pitäisi yrittää poistaa häiriö jollakin seuraavalla tavalla tai useammalla niistä:

- Kohdista tai sijoita antenni uudestaan.
- Lisää laitteen ja vastaanottimen välistä etäisyyttä.
- Kytke laite pistorasiaan, joka on eri piirissä kuin vastaanotin.
- Ota yhteyttä jälleenmyyjään tai kokeneeseen radio-/televisioasentajaan.



**/// BRAVILOR  
BONAMAT**

© 02 - 2022

VHH

